

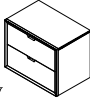





ASSEMBLY INSTRUCTION

ITEM NO : B360-43
NIGHTSTAND 2 DRAWER

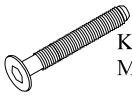
Thank you for purchasing this quality product. Be sure to check all packing material carefully for small part, which may have come loose inside the carton during shipment. Identify and count all parts and compare with the Part List below

PART LIST				HARDWARE LIST							
1	 Assembly Body	1 pc	2	 Bunfeets	4 pcs	A	 KD Bolt M6 x 70 mm	4 pcs	C	 Lock washer Ø6 x Ø13 mm	4 pcs
						B	 Flat washer Ø6 x Ø16 mm	4 pcs	D	 Allen key L - 4 mm	1 pc

NOTE :

These part are cumber some and heavy. Therefore, two people are recomended in order to prevent personal injury and insure the parts are not damaged during the assembly.

△ Important Notes

- *Keep all hardware parts out of reach of children!
- *Tighten screws periodically! With the use of this product bolts and screws may become loose over time!
- *Don't attempt to modify parts!

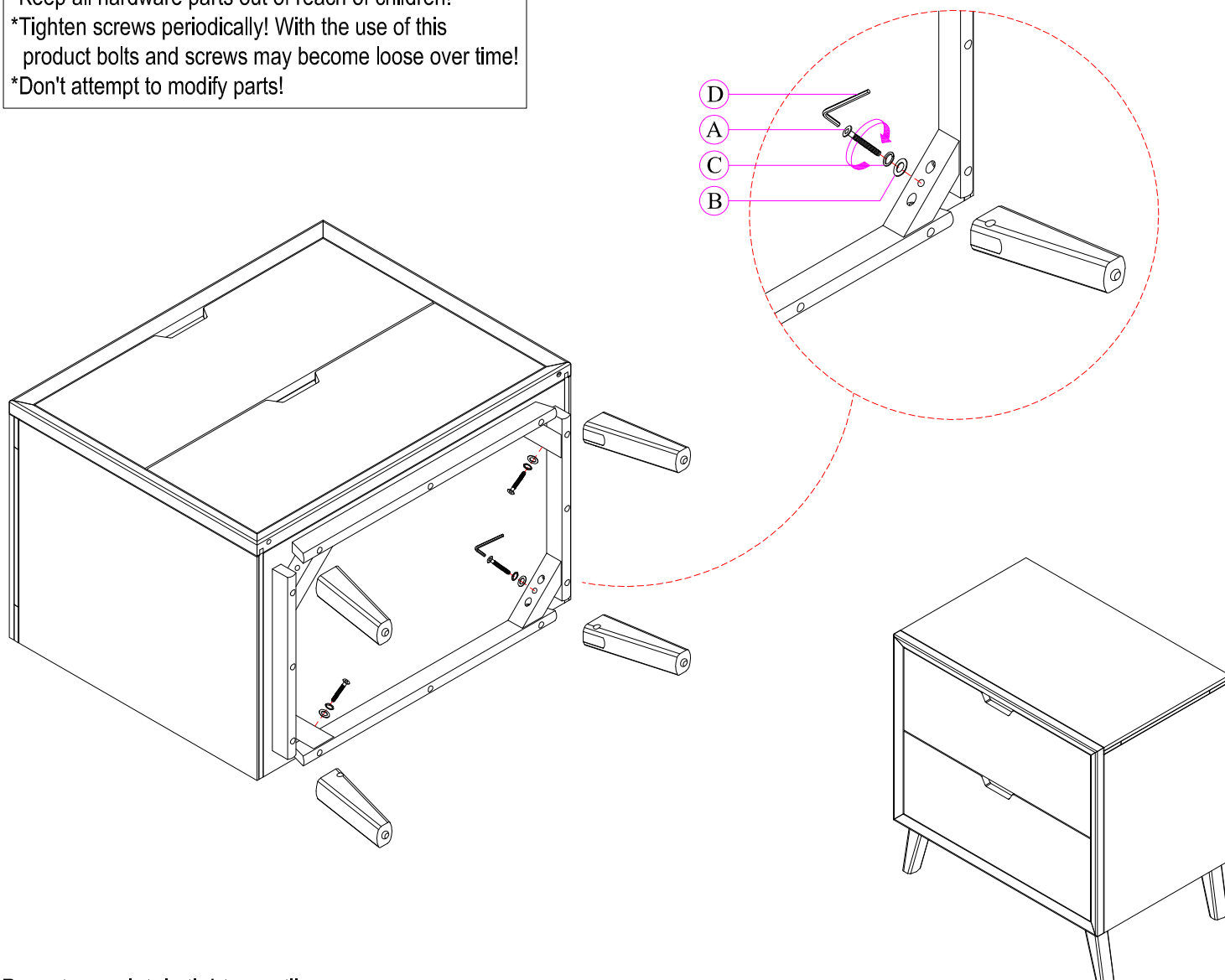

Do not completely tighten until the item has been fully assembled

MADE IN INDONESIA