



**INSTRUCTIONS D'ASSEMBLAGE**  
**ASSEMBLY INSTRUCTIONS**

---

**M**ONARCH  
SPECIALTIES INC.

# I 1390

---

**TABLE A MANGER -**  
**36"X 60" BOIS PLAQUE GRIS ANTIQUE**

**DINING TABLE -**  
**ANTIQUE GREY VENEER 36"X 60"**



**POUR DE L'ASSISTANCE OU POUR COMMANDER  
DES PIÈCES CONTACTEZ NOTRE DÉPARTEMENT  
DE SERVICE À LA CLIENTÈLE.**

**FOR ASSISTANCE OR TO ORDER PARTS  
CONTACT OUR CUSTOMER SERVICE DEPARTMENT**

**WWW.MONARCHSERVICE.COM**

**LISTE DES PIÈCES**  
**PARTS LIST**

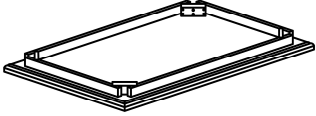
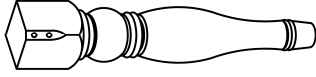
PIÈCE / PART #	IMAGE	DESCRIPTION	QTY / QTÉ
1		TABLE TOP SURFACE DE TABLE	1
2		LEG PATTE	4

**LISTE DES PIÈCES DE MONTAGE**  
**HARDWARE LIST**

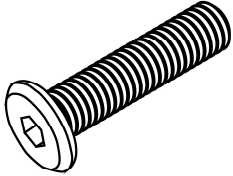
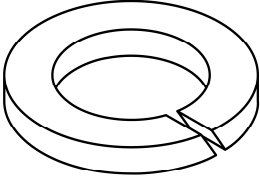
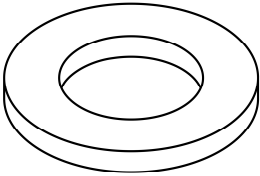
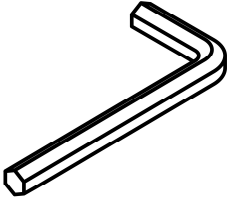
PIÈCE / PART #	IMAGE	DESCRIPTION	QTY / QTÉ
A		<p align="center">ASSEMBLING BOLT - Ø3/8" X 3 1/8" BOULON D'ASSEMBLAGE - Ø3/8" X 3 1/8"</p>	8
B		<p align="center">LOCK WASHER - Ø3/8" X 1/2" ENTRETOISE DE MÉTAL - Ø3/8" X 1/2"</p>	8
C		<p align="center">METAL WASHER - Ø3/8" X 7/8" RONDELLE DE MÉTAL - Ø3/8" X 7/8"</p>	8
D		<p align="center">HEX KEY CLÉ HEXAGONALE</p>	1



OUTIL DE VÉRIFICATION DE DIMENSIONS DES PIÈCES  
HARDWARE DIMENSIONS VERIFICATION TOOL



ÉTAPE / STEP 1

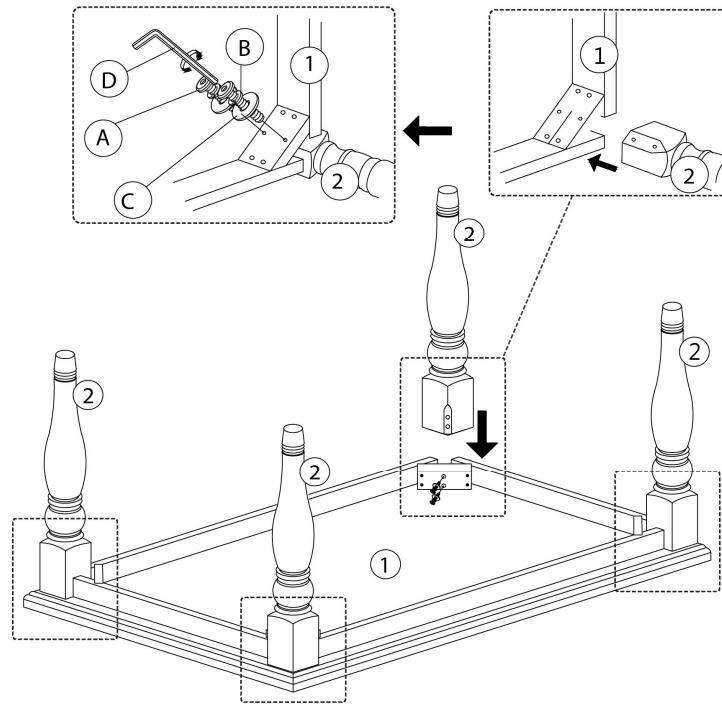

ÉTAPE / STEP 2

