











ASSEMBLY INSTRUCTIONS

ITEM NO : D626-61

UPH Dining Chair

Thank you for purchasing this quality product. Place all wooden parts on a clean and smooth surface such as a rug or carpet to avoid the parts from being scratched. Be sure to check all packing materials carefully for small parts may have come loose inside the carton during shipment, clarify and count all parts and compare with the parts list below. Do not tighten all screws / bolts until all completely assembled.

PARTS LIST		
NO.	COMPONENT	QTY.
A	Head Post 	1 pc
B	Back Leg - Left 	1 pc
C	Back Leg - Right 	1 pc
D	Box Frame With Cushion Seat 	1 pc
E	Chair Leg 	2 pcs

HARDWARE LIST		
NO.	COMPONENT	QTY.
1	JCBC Bolt M6 x 30mm 	4 pcs
2	JCBC Bolt M6 x 70mm 	8 pcs
3	1/4" Spring Washer 	8 pcs
4	1/4" Flat Washer 	8 pcs
5	Ø14.5 Wood Bottom 	4 pcs
6	Allen Key M4 x 65mm 	1 pc

These parts are cumbersome and heavy. Therefore, two people are recommended in order to prevent personal injury and insure the parts are not damaged during the assembly.

Important Notes

- * Keep all hardware parts out of reach of children !
- * Tighten screws periodically ! With the use of this product bolts and screws may become loose over time
- * Don't attempt to modify parts !

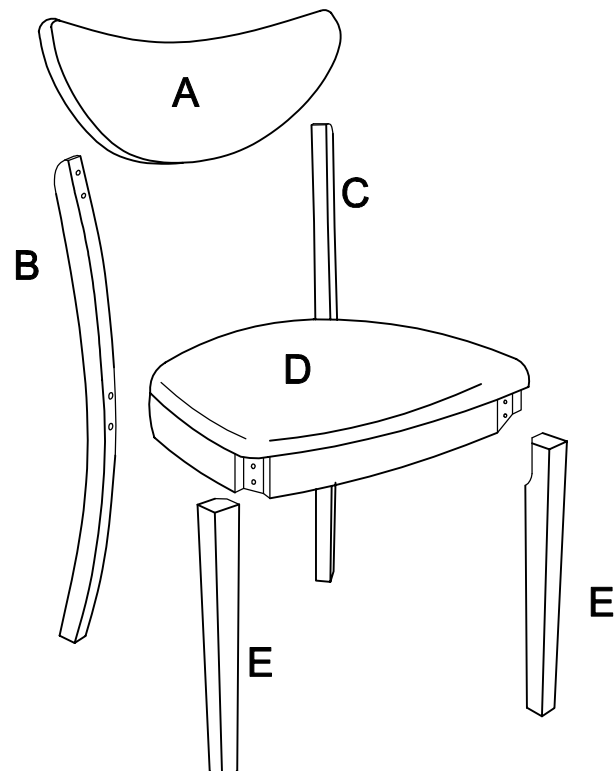

ASSEMBLY INSTRUCTIONS

ITEM NO : D626-61

UPH Dining Chair

STEP 1

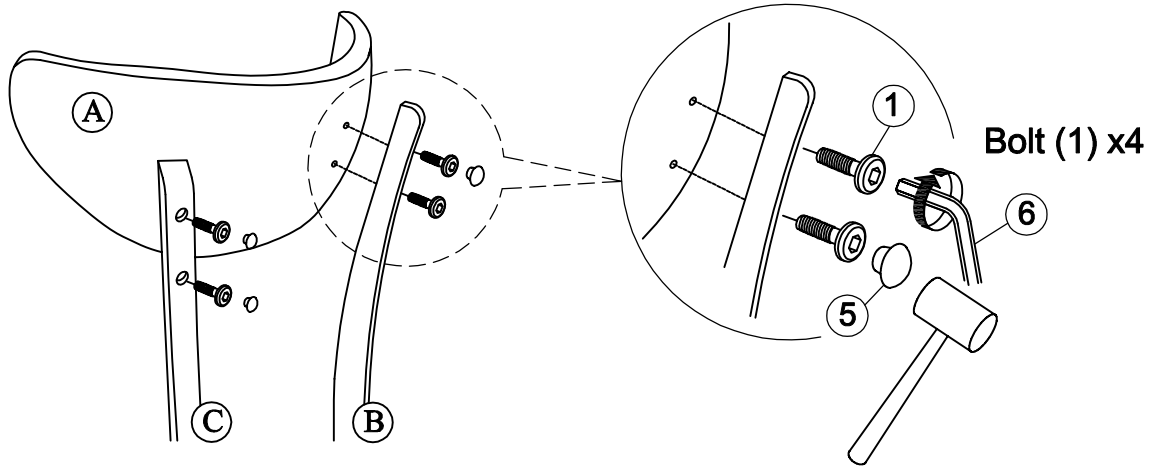

STEP 2

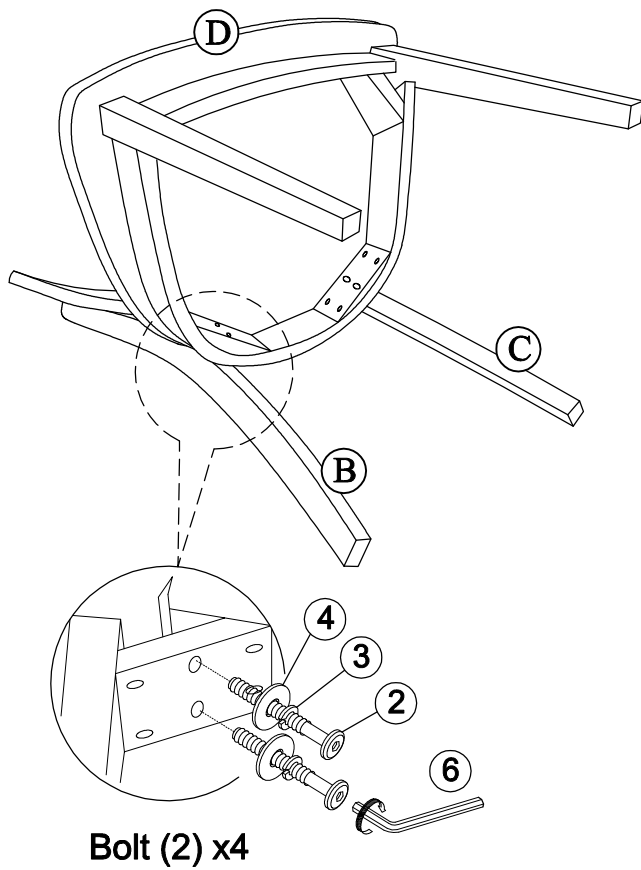

STEP 3

