

ASSEMBLY INSTRUCTION

Item No: D422-95





Description: COUNTER HEIGHT TABLE SET







IMPORTANT NOTE :

- Place all wooden parts on a clean and smooth surface such as a rug or carpet to avoid the parts from being scratched.
- Check to be sure that you have all parts and hardware.
- Remove all wrapping materials , including staples & packing straps before you start to assemble.
- Do not tighten all screws/bolts until all completely assembled.
- Keep all hardware parts out of reach of children !
- Tighten screws periodically ! With the use of this product bolts and screw may become loose over time !
- Don't attempt to modify parts !



PARTS LIST - TABLE

NO.	COMPONENT	QTY.
1	TABLE TOP 	1 PC
2	TABLE LEG - Left 	1 PC
2.5	TABLE LEG - Right 	1 PC
3	CROSS BAR 	1 PC
4	USB PLUG 	2 PCS





HARDWARE LIST - TABLE

NO.	COMPONENT	QTY.
A	JCBC BOLT M6 x 40MM 	14 PCS
B	JCBC BOLT M6 x 50MM 	4 PCS
C	1/4" SPRING WASHER 	18 PCS
D	CB SCREW M4 x 32MM 	4 PCS
E	ALLEN KEY 	1 PC

PARTS LIST - STOOL

NO.	COMPONENT	QTY.
5	WOODEN SEAT 	3 PCS
6	STOOL LEG 	12 PCS
7	RING 	3 PCS

HARDWARE LIST - STOOL

NO.	COMPONENT	QTY.
F	JCBC BOLT M6 x 40MM 	12 PCS
G	JCBC BOLT M6 x 50MM 	12 PCS
H	1/4" SPRING WASHER 	24 PCS
I	ALLEN KEY 	1 PC

STEP 1

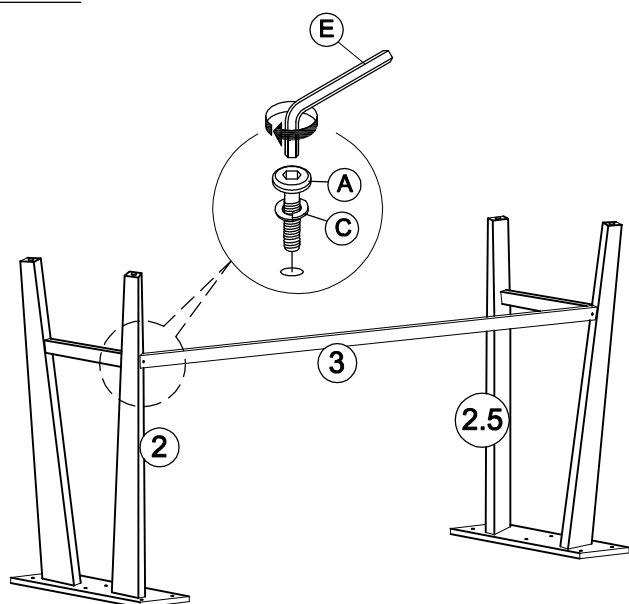

STEP 2

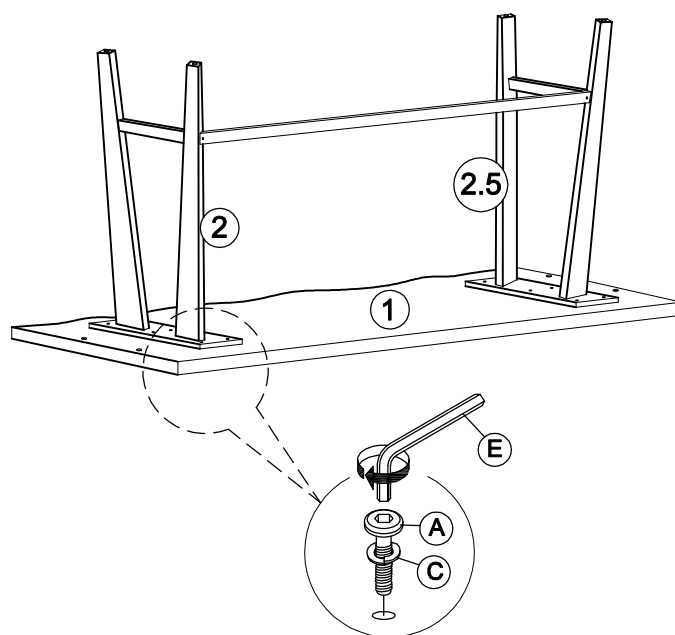

STEP 3

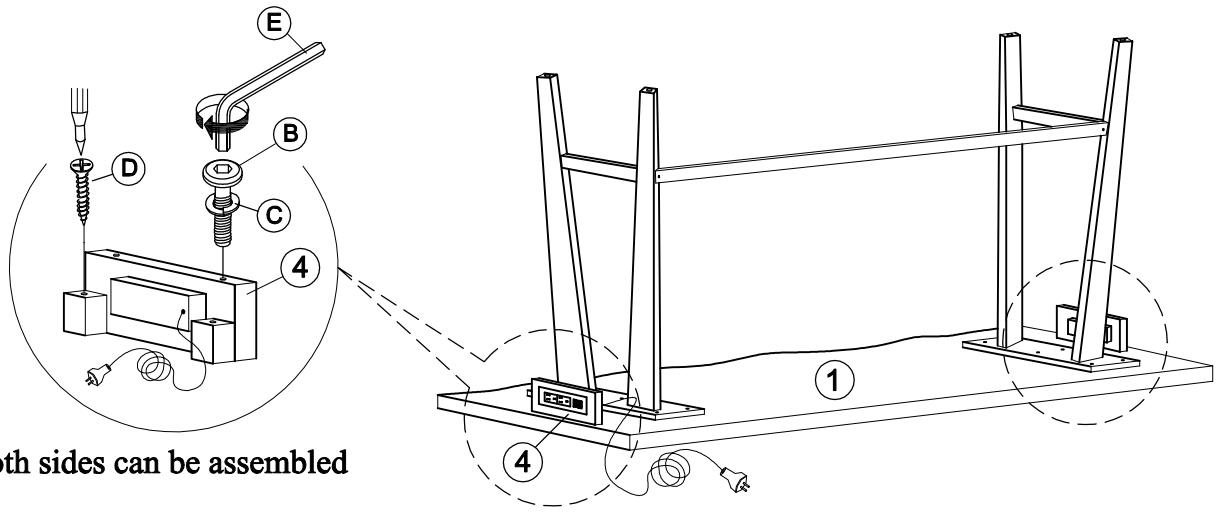

*** Both sides can be assembled**

STEP 4

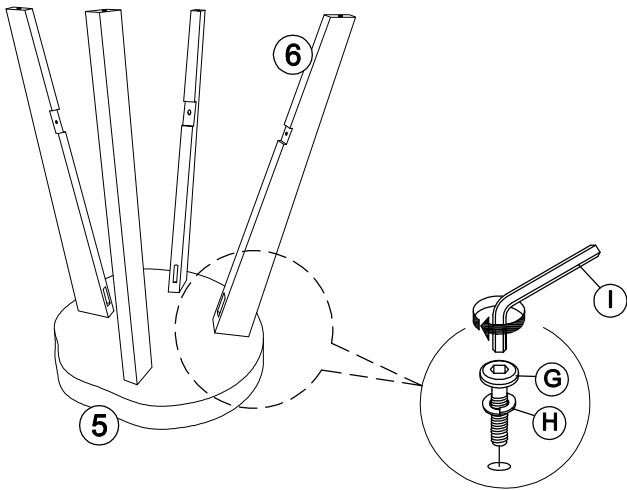

STEP 5

