

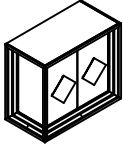



Assembly Instructions

ITEM NO: 95450

Thank you for purchasing this quality product. Be sure to check all packing material carefully for small parts that may have come loose inside the carton during shipment. (Note: Loosely thread all screws/bolts first. Once the item is assembled then completely tighten.)

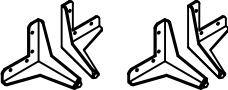
PARTS LIST:				HARDWARE LIST:				
No.	Description	Sketch	Quality	No.	Sketch	Description	Size	Quality
1	Cabinet		1 Pc	A		Allen Head Bolt	Ø6x20mm	16 Pcs
				B		Lock Washer	Ø9xØ13mm	16 Pcs
2	Metal Legs		4 Pcs	C		Flat Washer	Ø8xØ16mm	16 Pcs
				D		Allen Key	4x110mm	1 Pcs

STEP 1

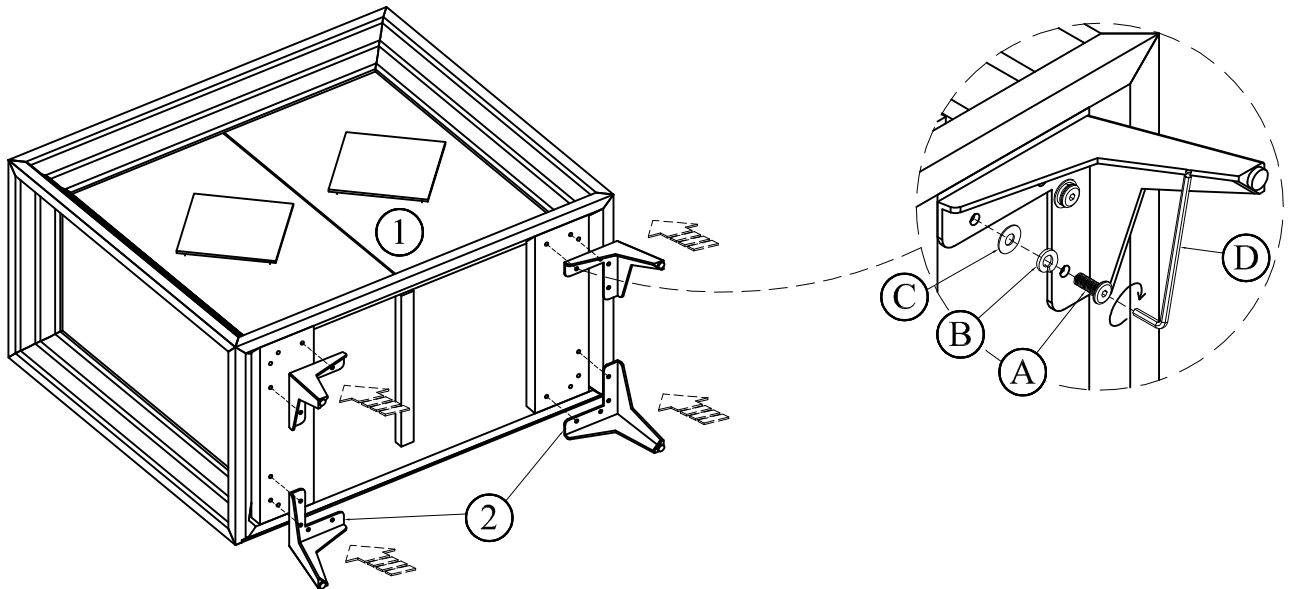

FINISH

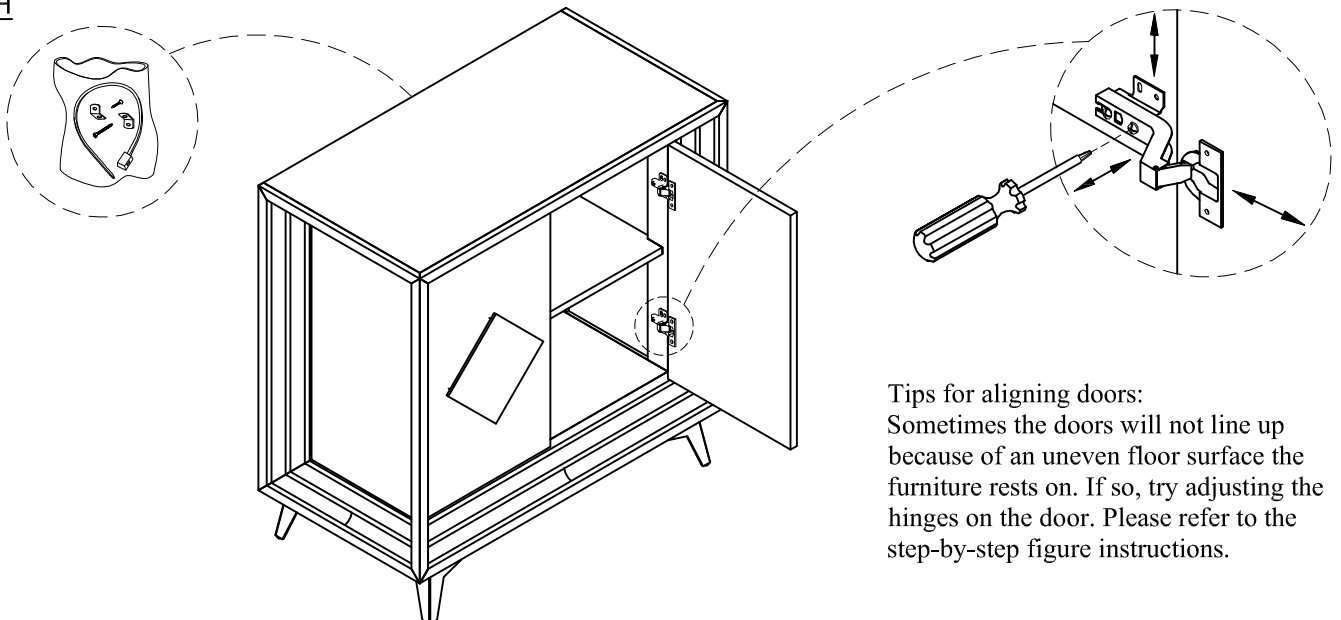

Tips for aligning doors:
Sometimes the doors will not line up because of an uneven floor surface the furniture rests on. If so, try adjusting the hinges on the door. Please refer to the step-by-step figure instructions.