

# ASSEMBLY INSTRUCTION

## SKU# 97524

**Before beginning**

- Unpack all parts and hardware to ensure you have all needed components for assembly.
- Read this guide cover before beginning assembly .
- Assemble this item on a soft surface such as carpet to protect finish.
- Proper assembly of this item requires 2 person & 20 minutes to assemble.

**CARE INSTRUCTIONS**

Wipe with a soft and dry cloth. To protect finish, avoid the use of chemicals and household cleaners. Any liquid in the table should be cleaned up immediately with a damp cloth.

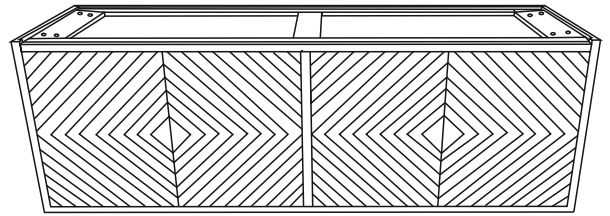

**BOX**

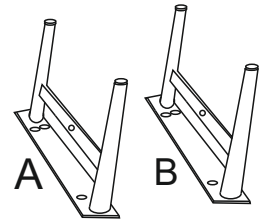



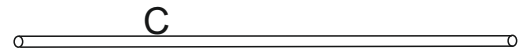



**LEG**



**SUPPORT**

**HOW TO ASSEMBLE**

- STEP-1 match marking C with C respectively.
- STEP-2 Insert allen bolt E then allen key D.
- STEP-3 Place the cabinet top upside on rug and match marking A with A and B With B respectively.
- STEP-4 Insert allen bolt F with spring washer H and flat washer G then tighten with allen key D.
- STEP-5 Turn the cabinet upside down, cabinet ready to use.

No.	Sketch	Description.	Size (IN)	Qty.	Ext.
D		ALLEN KEY	0.19"	1	0
E		ALLEN BOLT	0.31X1.18"	02	1
F		ALLEN BOLT	0.31X0.78"	08	1
G		WASHER	0.35X1 "	08	1
H		SPRING WASHER	0.35X0.5"	08	1
I		SCREWDRIVER		1	0

STEP- 1

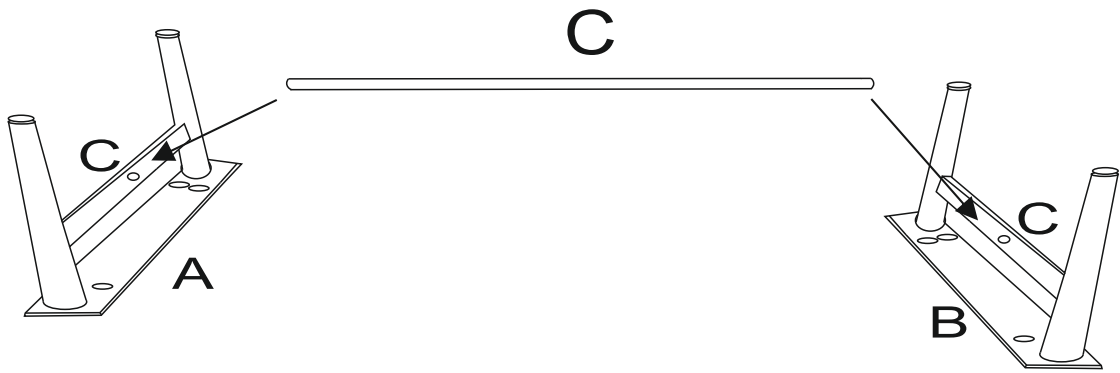

STEP- 2

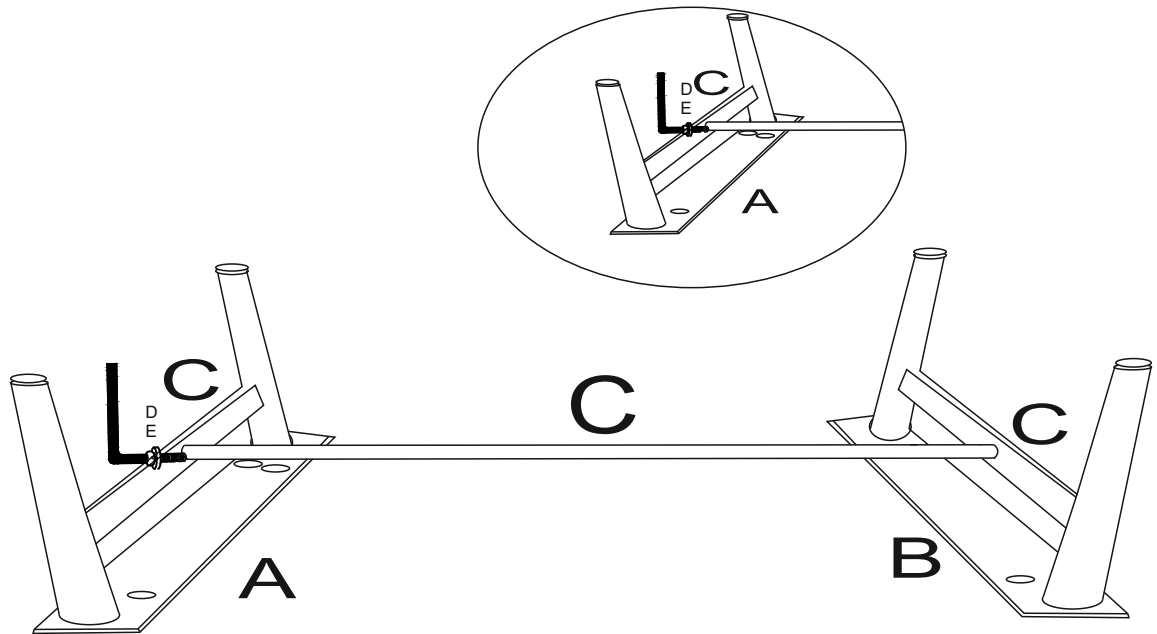

STEP- 3

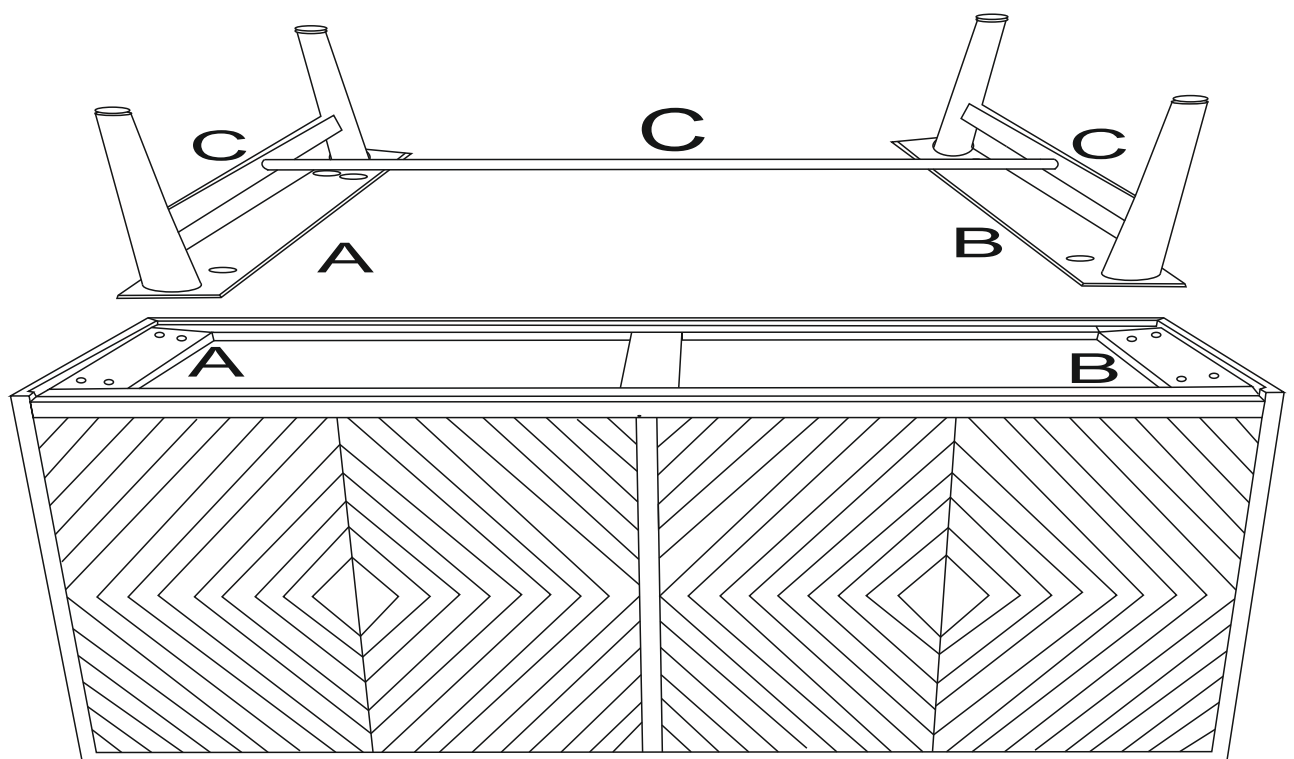

# STEP- 4

Tip for leveling of product:  
When the product rests on an uneven floor surface  
it will appear to be unbalanced. To aid in leveling, try  
adjusting the levelers on the bottom of each foot.

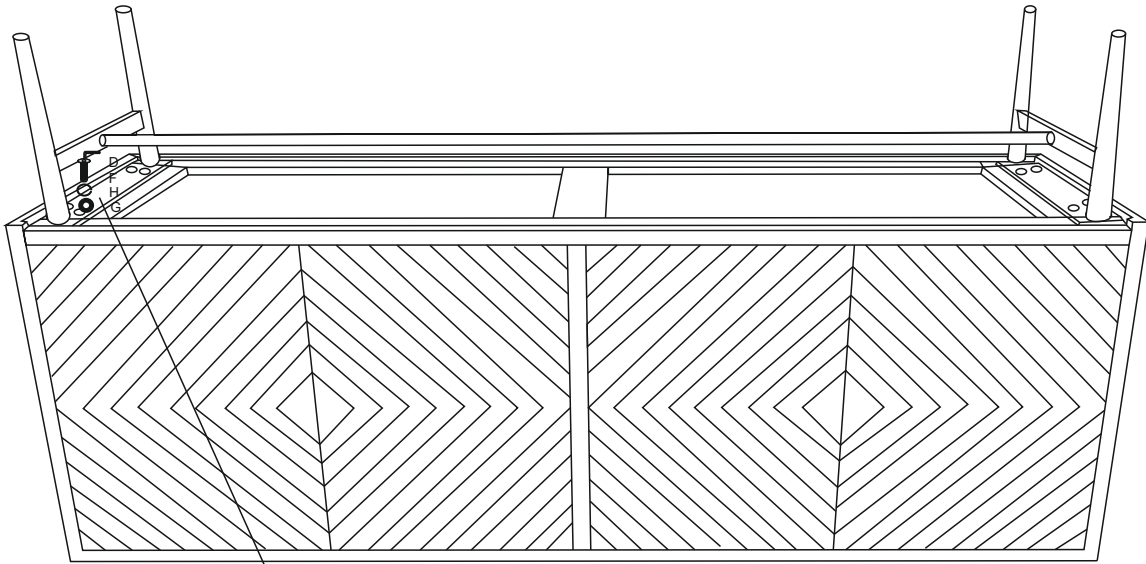
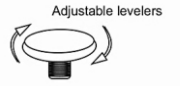

# STEP- 5

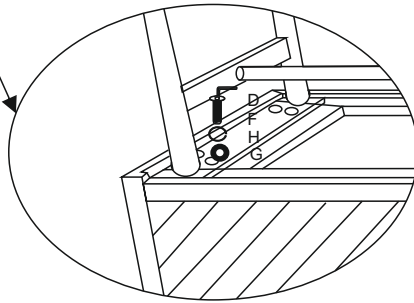

# FINAL

