

ASSEMBLY INSTRUCTION

SKU# 97543

Before beginning

- Unpack all parts and hardware to ensure you have all needed components for assembly
- Read this guide cover before beginning assembly .
- Assemble this item on a soft surface such as carpet to protect finish.
- Proper assembly of this item requires 2 person & 20 minutes to assemble.

CARE INSTRUCTIONS

Wipe with a soft and dry cloth. To protect finish, avoid the use of chemicals and household cleaners. Any liquid in the table should be cleaned up immediately with a damp cloth.

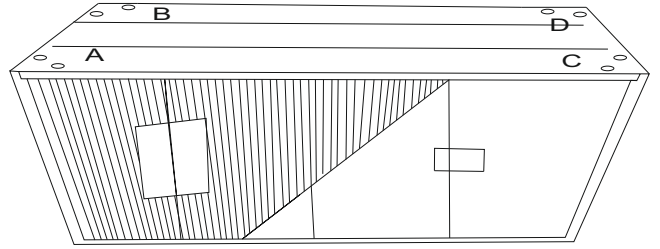

BOX

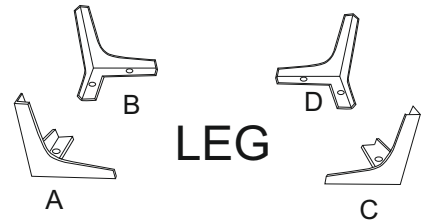





LEG

HOW TO ASSEMBLE

STEP-1 Place the sideboard upside on rug and match marking A with A and B with B and C with C and D with D respectively.

STEP-2 Insert allen bolt F with spring washer H and flat washer G then tighten with allen key E.

STEP-3 Turn the sideboard upside down, sideboard ready to use.

No.	Sketch	Description.	Size (IN)	Qty.	Ext.
E		ALLEN KEY	0.15"	1	0
F		ALLEN BOLT	0.23X0.78"	08	1
G		WASHER	0.35X0.78"	08	1
H		SPRING WASHER	0.35X0.5"	08	1
I		SCREWDRIVER		1	0

STEP- 1

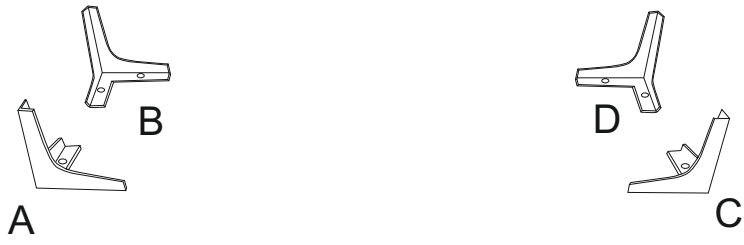

Tip for leveling of product:
When the product rests on an uneven floor surface it will appear to be unbalanced. To aid in leveling, try adjusting the levelers on the bottom of each foot.

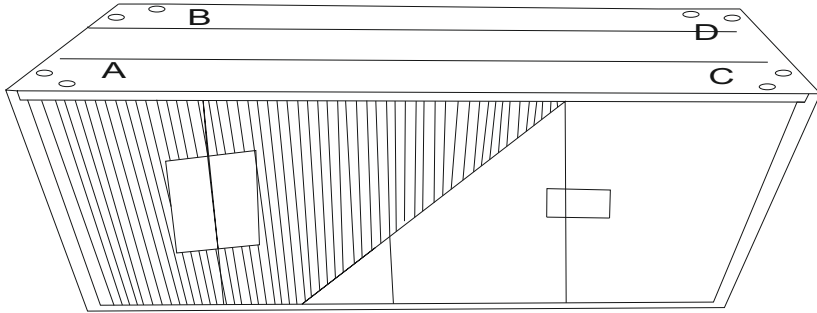
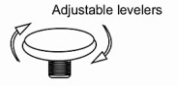

STEP- 2

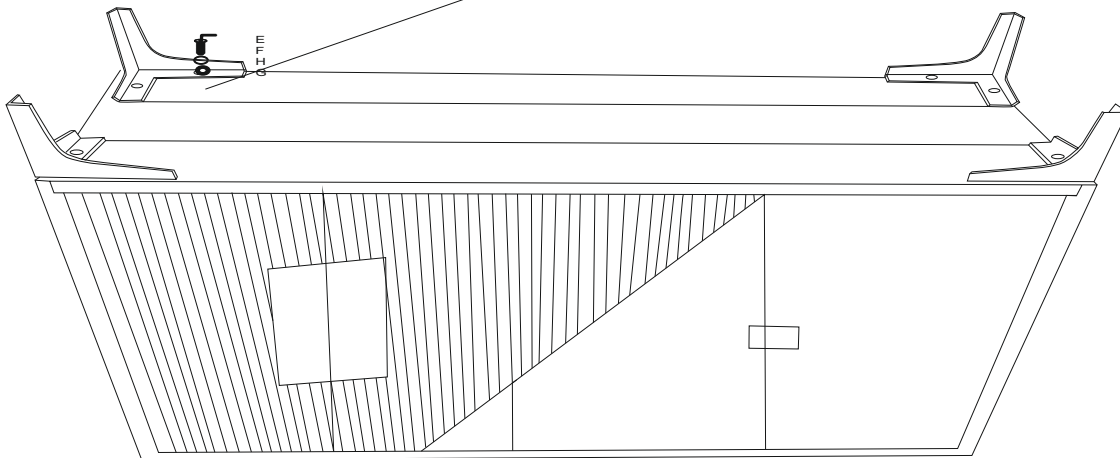
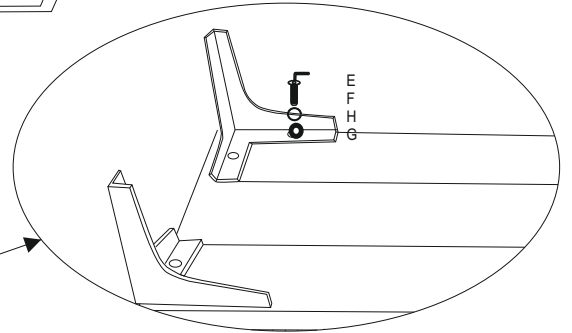

STEP- 3

FINAL

