













ASSEMBLY INSTRUCTIONS

T166-29 CHAIRSIDE TABLE

Thank you purchasing this quality product. Place all wooden parts on a clean and smooth surface such as a rug or carpet to avoid the parts from being scratched. Be sure to check all packing materials carefully for small parts may have come loose inside the carton during shipment, clarify and count all parts and compare with the parts list below. Do not tighten all screws/bolts until all completely assembled.

PARTS LIST		
NO.	DESCRIPTION	QTY
A	TOP	1PC
B	SIDE PANEL-WOOD	1PC
C	SIDE PANEL-ACRYLIC	1PC

These parts are cumbersome and heavy. Therefore, two people are recommended in order to prevent personal injury and insure the parts are not damaged during the assembly.

HARDWARE LIST				
NO.	DESCRIPTION	SKETCH	SIZE	QTY
1	ALLEN BOLT		1/4"*3/4"	4PCS
2	FLAT WASHER		1/4"*16mm	4PCS
3	LOCK WASHER		1/4"	4PCS
4	ALLEN WRENCH		4mm	1PC
5	THREADED STUD		5/16"*75mm	3PCS
6	FLAT WASHER		5/16"*16mm	3PCS
7	LOCK WASHER		5/16"	3PCS
8	NUT		5/16"*6mm	3PCS
9	FLAT WASHER		5/16"	3PCS
10	MAP		Ø1-1/2"	3PCS
11	WOOD DOWEL		Ø10*30mm	2PCS
12	WRENCH		13mm	1PC

△ Important Notes
 *Keep all hardware parts out of reach of children!
 *Tighten screws periodically! With the use of this product bolts and screws may become loose over time!
 *Don't attempt to modify parts.

Diagram1

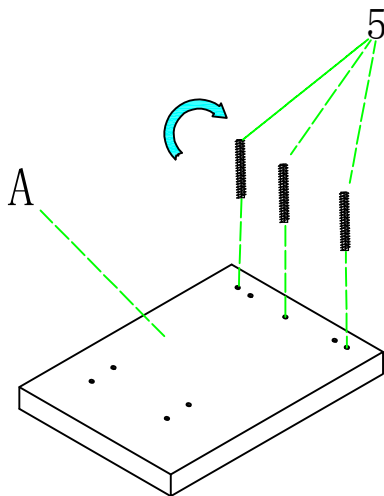
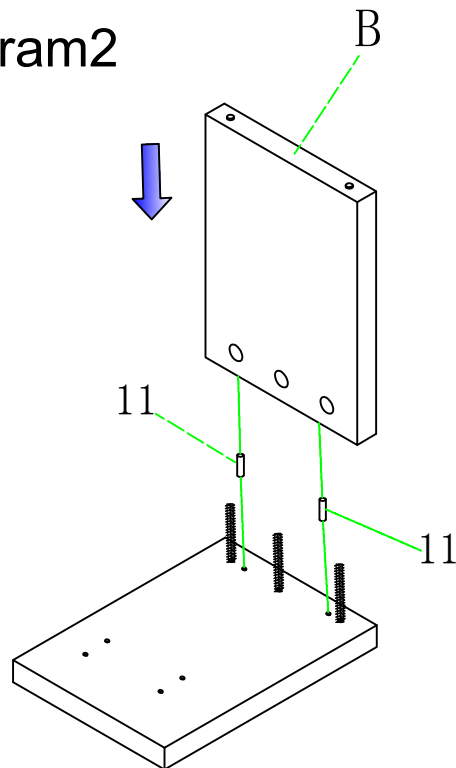

Diagram2



Begin by placing the table upside down on a smooth surface please make sure the surface is not abrasive.

Diagram3

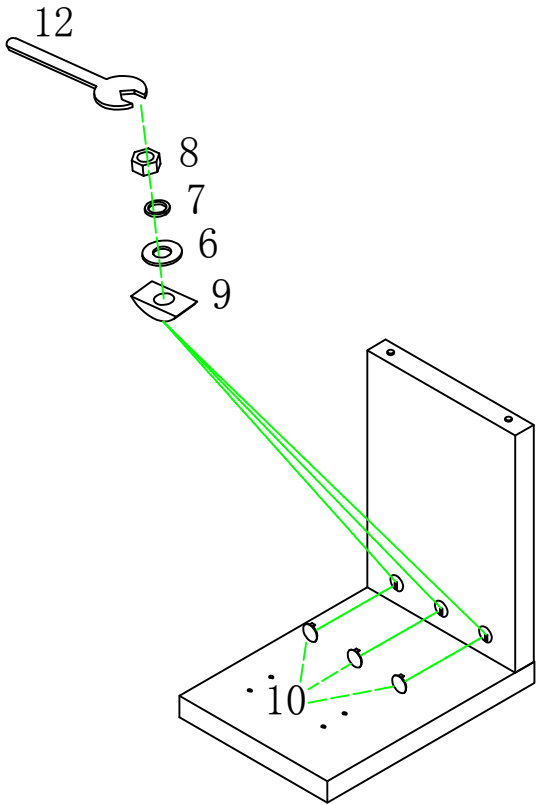

Diagram4

