









Part List and Hardware List

PART	DESCRIPTION	PICTURE	QUANTITY
A	CANOPY		1X
B	MOUNTING PLATE		1X
C	SIDE SCREW		2X
D	PLASTIC CEILING MOUNTS		2X
E	SCREW		2X
F	PLASTIC CONNECTORS		3X
G	CORD GRIP		1X
H	SHADE		1X

PREPARATION

Before beginning assembly of product, make sure all parts are present. Compare parts with package contents list and hardware contents list. If any part is missing or damaged, do not attempt to assemble the product. Estimated Assembly Time: 10 minutes.

1

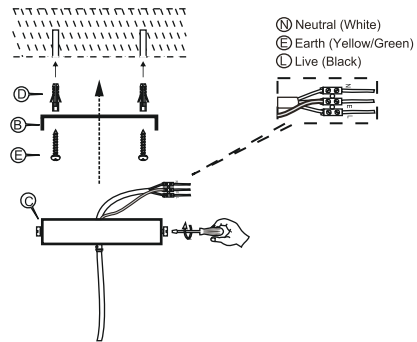

- (1) Secure the mounting plate (B) with screw (E) in the Plastic Ceiling Mounts (D).
- (2) After secure the mounting plate, Connect the two power wires coming out from the ceiling to the White Plastic Connector (F).

Step 1

2

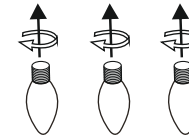

- (3) Tighten the canopy (A) with side Screw (C) to the mounting plate (B) and tighten the screw on plastic cord grip (G).
- (4) Secure the Light Bulb / 3 x E12 into the Lamp Holder

Step 2

CARE AND MAINTENANCE

1. Do not use acids or alkaline cleaning agents.
2. Sharp objects will damage and scratch the surface.
3. Wipe the surface with a soft, damp cloth.
4. Please make sure that you have all parts indicated before you begin assembly of this item
5. This item should be assembled on a soft surface to prevent scratching the finish during assembly
6. This item may require periodic tightening

Jade Beaded Chandelier

TOV-G18306

TOV

JADE BEADED CHANDELIER ASSEMBLY INSTRUCTIONS

